

Ever Wondered How You'd Go Building Your Own Boat?

Here's A Heck Of A Good Way To Find Out!

Check It Out Carefully - We Set It Up With YOU in Mind!

By John Pontifex at Plate Alloy Australia, Victoria

For those few who have not read the 5.8m Runabout build article in PAB-4, it was that article which prompted PW to call the team at Plate Alloy in Melbourne and ask what vessel we were going to put forward for the build article in PAB-5.

The team at Sea Media get lots of calls and emails, as I am sure you can imagine, and the decision was quickly made for a smaller, crossover type side console vessel.

A vessel under 5 metres, with a casting deck, good for darting up creeks, lots of usable deck space and a stable, robust and good performing hull. This size is ideal on a single axle trailer, (just saved another thousand, I hear you say!), and light enough to be towed by a medium sized car.

So with that, we decided on the side console version of our 4.8m vessel, with full chine and self draining deck. This is a popular vessel, and built entirely from 4mm, is one tough little boat. For those interested, the vessel also comes in a centre console and a runabout version.

At 4.8m long with full height frames and inter costal stringers, this vessel is quick and easy to set up and should take the first time builder less than 70 hours to build.

(Continued Over . . .)

DIY 480

**Also available in different configurations including a centre console, runabout and a small cuddy cabin.*



The full test report on this craft was published in F&B March 2010 #163, and is now available to download from the SEA Library www.seamedia.com.au



Side* Console





4.8m Rendered view

This is the boat we are going to build in this article. It can be built upside down, but for the home builder, we recommend to build the boats the right way up. Always be careful when lifting, and particularly rolling the boat over. If you are unsure about anything, consult a professional. The boat can also be fitted out with various options. This vessel was designed from a brief supplied from the Sea Media team, and includes a side console with side mount controls and a back and front bimini.

I would have started this article with information about welding and getting experience etc, but I would suggest you read the welding article (**Pages 70-78**) before the vessel build article.

When building the boats, we use the MIG welding process.

In this article we will tell it how it is, starting with safety, welders, set up and jigs.

Always wear appropriate safety equipment when starting a project like this, including long sleeved shirts and long trousers and plenty of sunscreen.

Get Experience.

Firstly, I must say that we recommend all budding boat builders attain some competence and formal training in welding. The local TAFE or university can help, and many offer welding courses.

In Melbourne, we run three or four Boat Building and Welding courses per year. These are held on Saturday mornings from 8am -12pm for 8 consecutive Saturdays. We will also be hosting at least one, week long course for those who may be interested in attending from interstate. If you are interested in attending these courses, please keep an eye on the website for course dates, at www.platealloy.com.

The Welder.

A minimum requirement is a 240 Volt welder, and we recommend 240 - 250 amps minimum. We use and recommend Unimig welders; these are the machines we use at our Boatbuilding and Welding courses.

The welding machine is critical to the boatbuilding process. If you buy the wrong welder, the whole welding experience will be bad, and you will not be at all enthusiastic about embarking on your own boat building project.

However, if you buy the right machine, and are able to

produce good, consistent welds in a short time, you will have the confidence, ability and drive to build your own boat.

To set up a welder to weld aluminium, we fit a Teflon liner to the MIG gun, also "U" groove rollers and oversize tips. The issue with welding aluminium is the feeding of the wire to the welding tip.

Aluminium wire is soft, and the combination of low friction liners, a straight lead (minimize the kinks), clean good quality wire, a clean tip and liner gives you the best chance of attaining excellent welds.

We use 1.2mm diameter, 5356 grade aluminium wire (do not use cheap wire). We only use the best wire, and it is worth every cent. So to recap, welder set up, 5356 wire, ("Safra" is our preference), Teflon liner, oversize tips (marked 1.2A, they are actually 1.4mm diameter), and "U" groove rollers.

The reason for the "U" groove rollers is with the soft aluminium, a standard "V" groove roller will put a flat on the two contact points of the wire. A complete half circle will give the wire the maximum grip, and have less chance of the wire sticking to the liner.



Above: Showing clogged liner with aluminium particles

It is also important to blow out the liner every day. Small particles of aluminium dust are carried through the

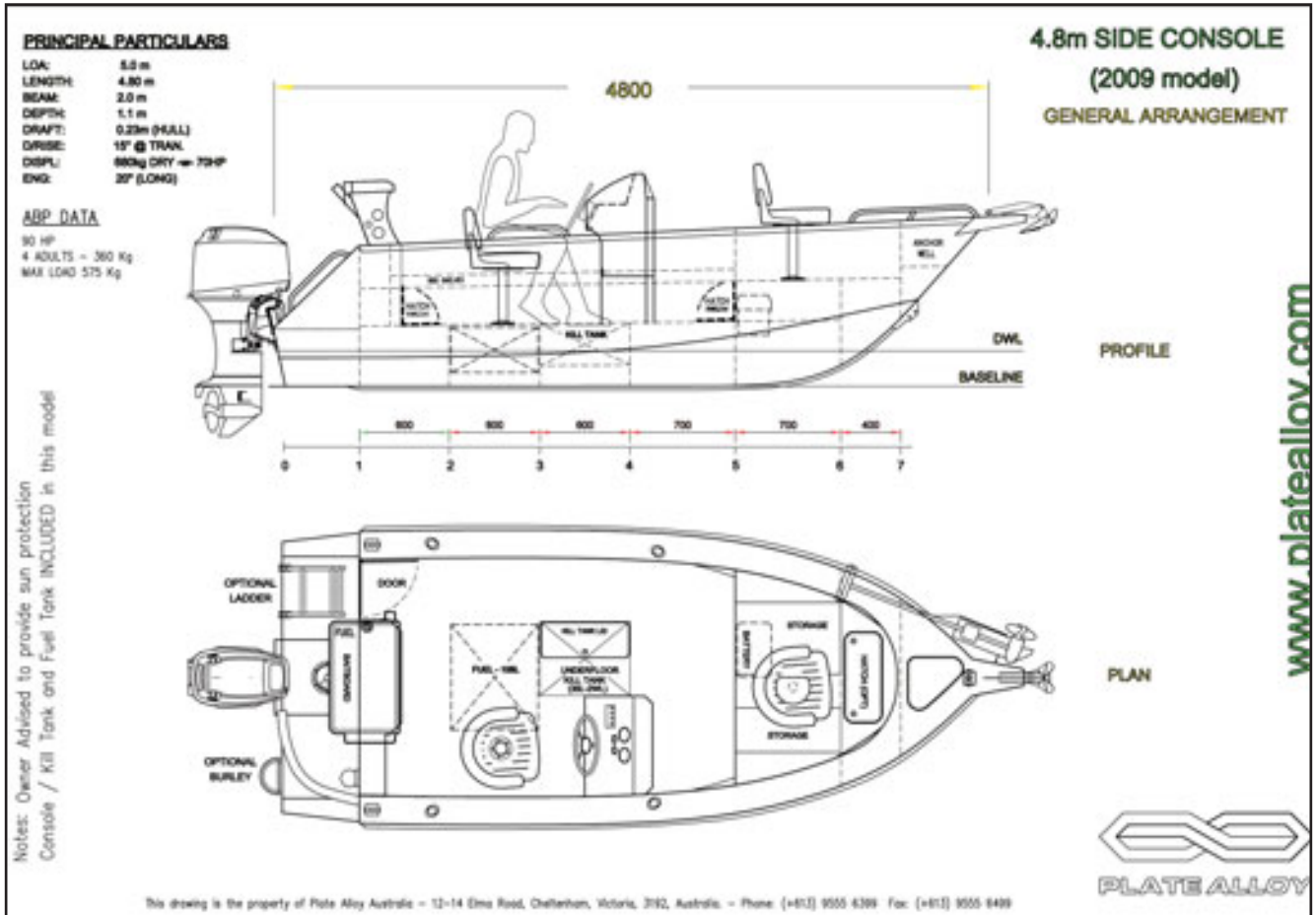

liner and can block at the contact tip, and accumulate at scratched areas on the inside of the liner. This increased friction and intermittent blockages inhibit smooth feeding of the wire to the welder tip. To reduce this possibility, pull out the wire and unscrew the tip and blow out the liner, and the brass neck feeder tube, as shown in the picture (at left) every day.

The Boat and the Build.

Kits ready for despatch

We cut the kits on our CNC cutting machines. The kits are delivered in flat pack form, with normally 6.2 m x up to 2.0m wide sheets, in addition to extrusions, bollards, scuppers, drain plugs, inspection ports, construction drawings, a CD, (with build pictures), and a jig frame



drawing. Timber jig frames, made from CNC machined 18mm thick MDF are also included with all kits.

We are also able to cut anchor winch mounting holes, rod holders, speaker cutouts, dash glove box cutouts, front hatch cutouts and all other holes to save you time. When the kit is ordered, the customer can fill out a check sheet indicating which cutouts are required to be cut. Other parts included in the kit are under-shelf LED light brackets, bow roller brackets, transducer mounting plates, towing eye, bilge pump mount plate, and tag pulling plates for pulling the bottom plates together.

With all of our kits, optional items such as dash modules, consoles, custom fuel tanks, seat boxes, bait boards (etc) can be supplied complete with cut outs for hatches and other components. We stock fit out items such as hydraulic steering, anchor winches, switch panels and the like and these parts can be supplied with the kit or at a later date when undertaking the vessel fit out.

For local and Victorian deliveries, we have a truck and also a 6m extension trailer and can organize delivery if required. If the kit is being collected, it can be stacked on top of a car-carrying tandem trailer.

We have been asked if we can cut kits designed by other Naval Architects, and the answer is "Yes". In this instance, it is best for the Architect to contact us to discuss this option.

Let's Start The Build . . .

The first step is to set up the jig. Timber, or a steel angle frame is set up to the measurements as shown on the jig drawing, and the MDF frames are bolted to it.

We make a steel frame, and put wheels on the corners, and jacking bolts to level it. Once put in place and leveled, the boat can be tacked and then welded together, and once done, the jacking bolts can be removed and the boat moved in and out of the workshop as required, on the trolley.

A drawing of the boat jig / trolley is included with the kit, and shown below, and the good thing is that all our kits can be made on a similar frame. You can always make the trolley a little longer in case you or a friend decide to

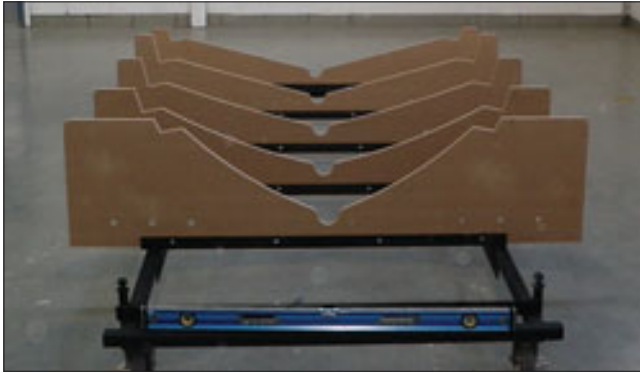

upgrade to a larger boat down the track, the same frame may be used.

Starting at the back, (aft) of the boat the frames are placed in the jig, Frame1, Frame 2, Frame3, etc..

So, step 1 is to set up the frame jig and check the level.

It is recommended that any builder view the construction sequence on the CD provided with the kit, so they can get the overall idea in their mind in what order the boat goes together.

When the kit is delivered, the parts are held into the sheets with small tags. All the parts must be taken out of the sheets, and the edges sanded and cleaned. We stack the parts into nest piles so they are ready to be fitted into the boat. It is good practice to keep a clean shop, as this will keep things organized and reduce hazards around the building area.

It is a good idea to leave out the last frame jig; we will fit this later on. The reason for doing this is that it will tend to push the bottom plate up and make it difficult to fit the bottom sheets in place.

Once the jig is leveled, place the bottom sheet into the jig. Centre the plate and place the other bottom sheet into the jig. Align the marks at the outer edge with the timber frames. i.e.: frame 2 is aligned with the frame 2 mark on

NOTES:

- * SET JIG LEVEL
- * SUGGEST JACKING BOLTS AT CENTRE AND CORNERS
- * JACKING BOLTS - TYP 18MM ALL THREAD IN TUBE W/LARGE WASHERS AND NUTS
- * CHECK ALL FRAMES LEVEL BEFORE KIT ASSEMBLY
- * BOLT TIMBER FRAMES TO JIG, TOP EDGE WELD ANGLE TO BASE FRAME
- * RECOMMEND LARGE FIXED / SWIVEL CAST IRON WHEELS AT CORNERS AND MIDDLE
- * TYP. MATERIAL: SENSORS / 75X75MM OR SIMILAR
- * USE DIA. 35.4 ROUND TUBE (OR BROOM HANDLE) TO ALIGN FRAMES
- * DRILL AND BOLT FRAMES TO ANGLE SECURELY

4.8mm SIDE / CENTRE / RUNABOUT BOAT JIG

JIG GENERAL ARRANGEMENT

NOTE JIG FRAME SPACING

BOTTOM HOLE

2000.0

4100.0

WELD

JACKING BOLT

NOTES:

- * LEAVE JIG FRAME # OUT UNTIL BOTTOM PLATES ARE PULLED UP TO FRAME 4

TYPICAL JIG FRAMES (15-19MM PLY OR SIMILAR)

DETAIL

USE ANGLE TO SUPPORT TIMBER FRAMES

www.platealloy.com

PLATE ALLOY

This drawing is the property of Plate Alloy Australia - 12-14 Duna Road, Cheltenham, Victoria, 3192, Australia. - Phone: (+613) 9555 6399 Fax: (+613) 9555 6499

the aluminium plate. The boat jig supports are under the frames of the boat, and they match the hull profile exactly.

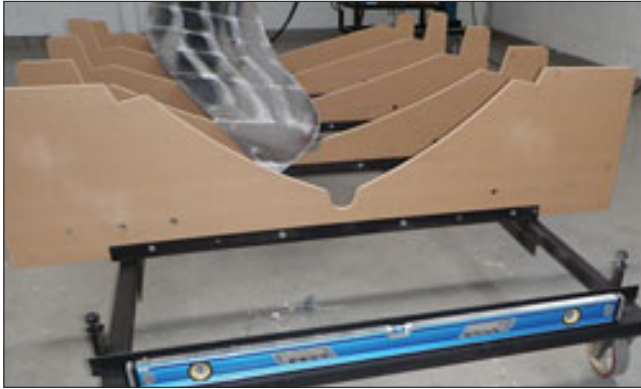

Place the bottom sheets into the jig. Notice the sanding marks on the parts where the frames and stringers are welded to the bottom sheets.

The bottom plates are aligned correctly when the marks are aligned precisely.

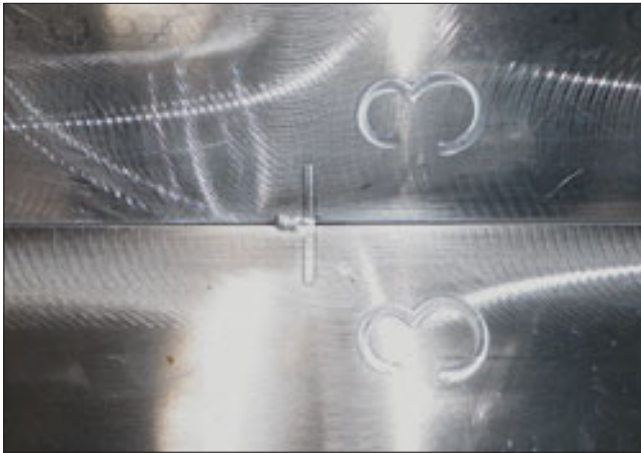

You can see clearly in the picture the alignment marks aligned at frame 3 in the picture above.

Before doing any welding, remember to thoroughly clean the areas to be welded with methylated spirits to remove any grease or dirt.



Start by putting one of the rear frames in position and

tack weld into place. The stringers are cut as intercostals, and are all numbered with the numbers facing toward the bow, and from the keelson, stringers are marked 1a, 1b,



1c, etc, outward toward the chine. The frame numbers are marked and are aligned with the marks on the bottom plates. These numbers are also marked on the chine and side plates for alignment.

Fit the stringers and tack all plates into place. We recommend to tack weld the entire boat together, this way distortion due to excessive heat is minimized.

As seen below, the forward timber jig frame has been left out until the forward frames have been inserted. The rear ring frame will locate the transom position.



There is a cutout at the base for the drain bung, and there is also a bilge pump bracket that is welded to the side. This plate will locate the bilge pump underneath the screw off inspection port access hatch.

The frames are easily fitted and the stringers can be fitted after each frame is fitted or they can be fitted after the frames are all in. When fitting, the frame position is aligned with the shallow engravings on the plate. When fitting the frames, they must remain vertical.

When fitting the stringers, the other option is to fit the stringers then the next frame, then stringers, then the next frame, tacking stringers into place as you go, this is



our usual preference. The stringers are aligned with the marks on the bottom plates. After placing each frame into position, check that the frame is aligned and level.

To tack the stringers, we tack at each end on the frame, and 3 tacks on one side, and 2 tacks on the other side in a staggered arrangement. The stringer should be fitted so that it fits hard up against the bottom plates. In the bay where the fuel tank is fitted, we fit angle to support the fuel tank. The plates either side of the fuel tank bay are stiffened vertically, and also have gusset plates where the deck longitudinals meet the frame.

This next table shows the typical welding sequence. A drawing, along with a plate layout drawing and construction drawings, are also included in all boat kits.

Toward the front, we use 2 Tonne rated "Come-A-Long"



hand winches to pull the plates together. We can supply these if required, or they are available at your local tool shop for about \$50- each.

After all the frames are in place, and the bottom sheets are together at the bow, it is time to fit the chine.

Starting at the rear, fit the chine plate, and tack weld all the way to the front, typically with tacks every 150mm. This is where the sanding of the plates is important. If the tags are not sanded flush, the plate will sit off on the tag, (such is the accuracy of the CNC cutting process).

Try to keep the welds uniform and in the same place. Notice on the chine, that the chine plate to bottom plate is fitted tightly, and the tacks get closer as you work toward to bow.

Push the chine up hard against the bottom plate. The

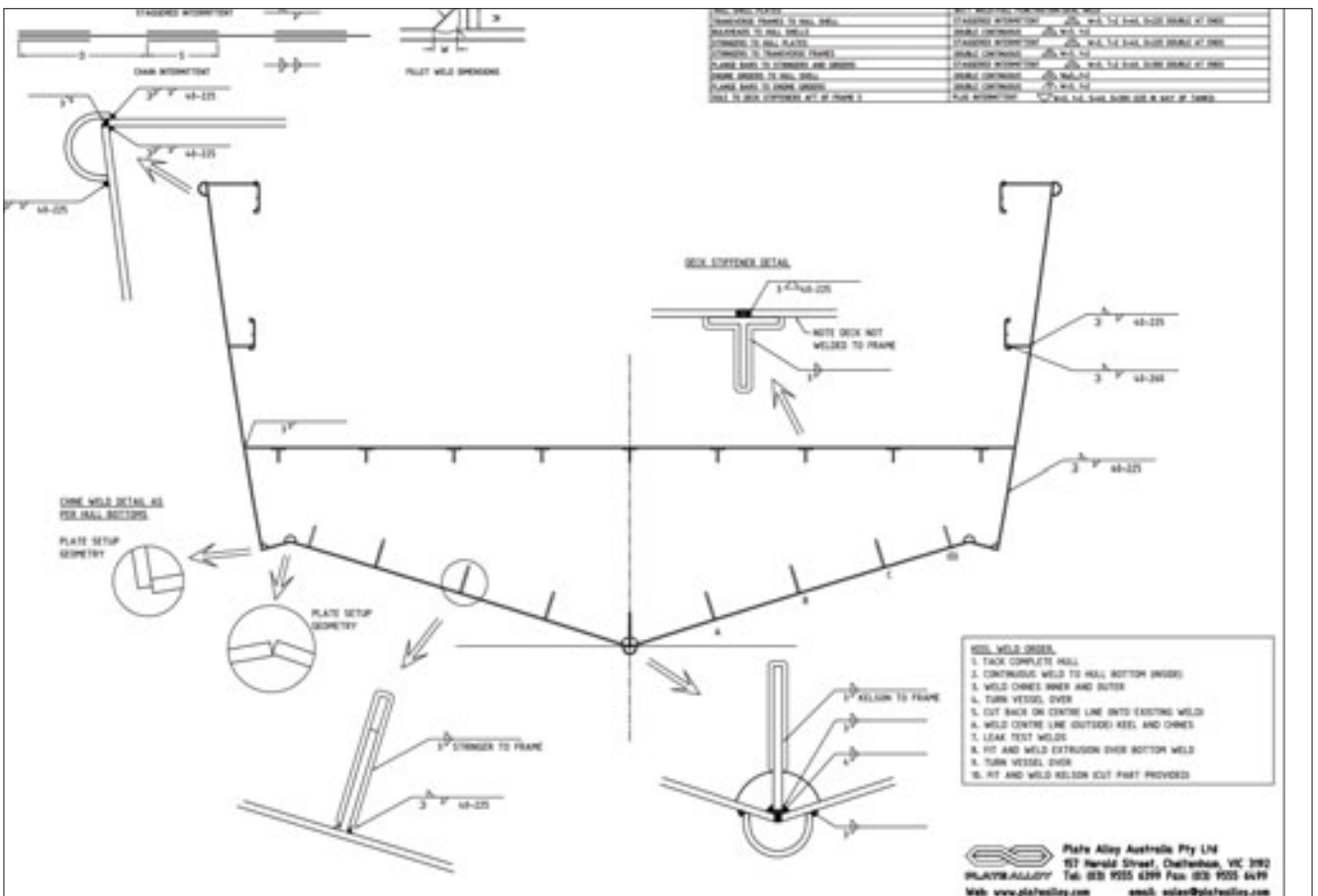

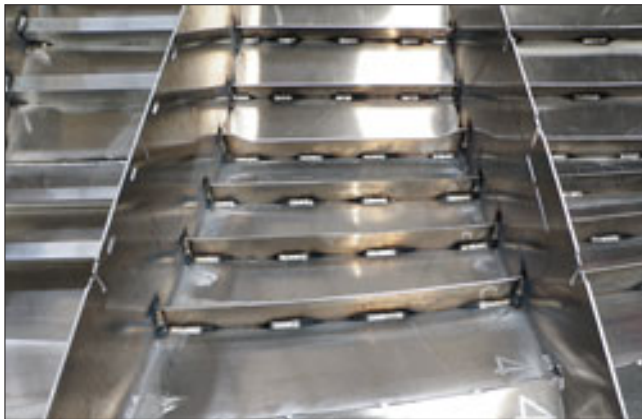
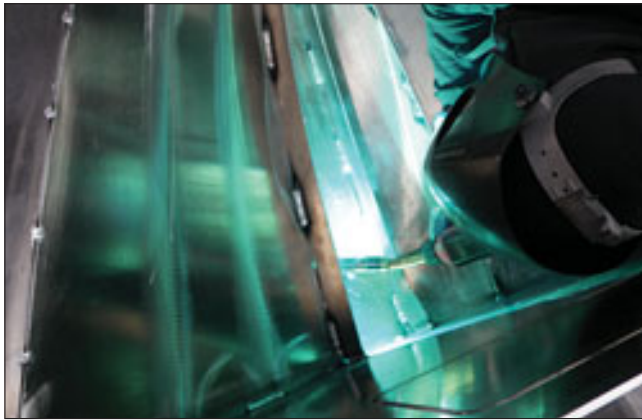

bottom plate may have to be lifted a little from underneath to allow accurate alignment of the chine.



After the chine has been fitted, we place small strips under the chine to support the side plates when they are fitted. It is BBQ time, when you need to invite your mates around to have a look at THE project, (it is convenient to then get them to hold and support the side plates while you tack them in place).

Starting at the rear, line up the marks on the plates with the frames, and tack the plates at the outer edge. Fit the plates corner to corner. As mentioned, tack the plates in place, with a tack every 150 to 200mm. Work forward, until the plates meet at the bow. On the inside, the frame is aligned with the mark on the side plate, and tacked in position. Toward the bow, place the tacks a little closer, say 80mm - 100mm. Toward the bow, there is more tension in the plate as you are bending it around and it would prefer to stay flat.



Once the side plates are tacked on, tack the front anchor plate in position, with a few small tacks. We need this in position, so we can position the forward gunnel plates, and the anchor locker plate.

Next, tack the rear gunnel plates, and the rear top plate in place. We also tack a strong-back (or stiffener) across the back of the rear panel at floor level and also where the door opening is to keep the panel straight. With all plate boats, where large panels are fitted to the boat, it is good practice to fit these strong backs, they have two functions, one is to keep these panels flat, the other is to dissipate heat near the weld area and thus reduce heat concentration in one area.

When fully welding, the weld sequence is such that the heat put into the boat is evenly distributed. The sequence is like the tightening of cylinder head bolts on a car. Diagonal forward back front, all done to balance the heat input from the welding process. Once welded, the braces, (or strong backs), can be removed.



Once the swim platform supports are put in place, the swim platform can be set up for a check fit. At this stage, we will fit the platform to check that the edges fit perfectly, and the edge alignment is perfect before welding. We will remove the platform and fit later on.

It is good practice to keep the work area clean and

organized.

With all the parts cleaned and stacked, they are ready to fit into the boat when required.



In the picture above, to get to this stage, if you have a hand to fit the side sheets, it will take about 5 hours to get this far. Typically, the entire boat will be tacked together in one day.



With both side plates fitted, the forward gunnel plate can be fitted. Braces are tacked in place using the measurements on the construction drawing. With the hull sides in the correct position, the gunnel plates can be fitted. You can see that the rear anchor plate is fitted and the forward gunnel plate with anchor cutout is tacked every 100mm.

The edge where the side gunnel plate joins the forward gunnel (anchor well) plate is prepared with a slight chamfer as edge preparation before welding. This is a butt type welding operation, where we usually tack or weld underside, then chamfer, or back cut, the top side and fully weld, then sand flat.

With this welding operation, you must ensure that the chamfer or back cutting is deep enough so that when sanded, there is sufficient weld material to hold the plates together.

Up forward, under the casting deck, we have made provision for a second battery in the event that a trolling



motor is to be fitted. The box is folded and tacked and welded in place.

There are a few things to consider before fitting the swim platform. The main item is the bilge pump outlet and the power wire to it.



The bilge pump is fitted to a plate at the bottom of the hull, and it is positioned underneath the removable deck hatch in the event that it is needed to be replaced or serviced.

These items must be considered before the swim deck is fitted. In the above picture, it is easily seen where we fit a 25mm diameter tube and bend it up and out a hole in the side plate. You can use a plastic skin fitting connected to a flexible hose, just remember that in 20 years when the hose perishes you may have difficulty poking it up to the skin fitting, with the swim deck fitted, all this has to be done through the small inspection port.



Up at the bow end, with the anchor well plate fitted, it is time to fit the bow sprit. These parts are all included in the kit, also heavy duty 8mm anchor roller plates with poly rollers. Before the underside of the bow sprit can be fitted, it is necessary to fully weld the forward side plates. The scrap of RHS tacked on top and laid flat will keep the bow sprit square and level.



With the sides on, the swim plate can now be fitted. Remember the provision for the bilge pump wire, a tube may be required for the wire to run in as we would not want the wire to lay loose and short circuit down the track. The bilge outlet is clearly seen out the aft starboard side. This will be covered with the rear swim angled cappings.

The swim deck is welded in and the capping is put into position (see pic with clamps lower left) and also welded in place.

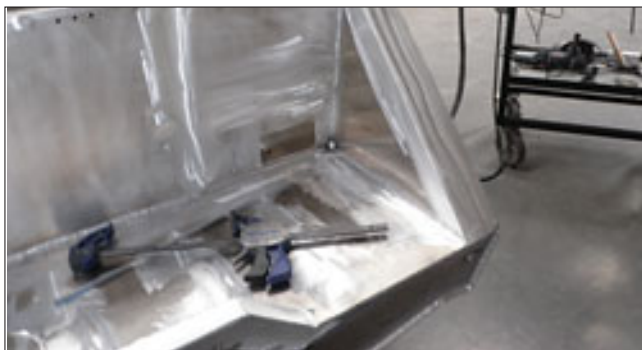

Down to the serious side of welding. It may only take a full day to tack the boat together, but there is lots of welding to do. Clean metal, good joint preparation, good



machine set up will result in getting good welds. The boat is welded on the inside, firstly the keel, then the inner and outer chine and then the gunnel corner.



Once the inside has been welded, time for a BBQ, a few more mates over to help you to roll the hull over. This hull at this stage will weigh around 400 kg. Be careful when lifting, if you are at all unsure, consult a professional.

With the inside fully welded and the boat flipped over, the sequence is to weld the underside, leak test and finish off the bottom. The first step is to clean out the welds, sand back the tacks, back cut using the lethal cutter, (pictured), and weld the bottom. We use these carbide tipped cutters on air grinders.

Note: These tools are very dangerous and should only be used by trained, confident and qualified operators.





Once the keel is welded and the inner and outer chine, the keel weld is tested for leaks.

The leak testing of the hull can be done a few ways, you can use a dye penetrant, but the easiest and cheapest, is to use soapy water, a brush and compressed air. You will need to have someone help you to do this. Starting at the front (or rear) go along each weld with the air gun on the inside and blow air directly at the weld area while someone sprays soapy water at the same position on the outside. Work your way along on all the keel welds, inner and outer chine and rear transom welds until done. If small pin holes are found, these must be ground out and re-welded.

Once tested with no leaks, the keel coaming and towing eye can be fitted.

Note: These external coamings are supplied pre-rolled in all boat kits.



With the outer chine welded, we use a large flat backed sander to get a good finish on the chine edge. Using a 60 grit fibre disc sanding pad, (with wax), is the best way to get a good finish. The sanding process may look easy but is a real skill to perfect. The best way is to keep the machine very flat and steady removing just a little material at a time. The inner chine weld is left as welded, just removing the high weld spots, usually the starts and stops of the welding operation.



Keep the sander very flat, and use a 6 or 7 inch fibre disc. Make sure you use wax on the sanding disc, this will make the discs last longer. Before painting, we will need to remove any wax residue on the hull with degreaser or prepsol.



The keel coaming is trimmed about 600mm from the end of the transom, and is capped at a very acute angle. This is to allow the coaming to roll over the last roller on the trailer if one is fitted at the lead in on the boat trailer. The reason for the trimming back of the coaming is to avoid cavitation resulting from turbulence during tight turns.

Once all the external underside welds have been



completed, leak test all of the welds in the same procedure as mentioned previously.

Flip the boat back into the jig. The bottom is now finished and if you have a trailer the boat can be put on it at this stage.

With both gunnel plates fitted, the shelves and floor plates can be fitted. Before fitting the shelves, the edge coaming is fitted and welded underside. Be sure to fit the edge coaming with the smooth rounded edge on the top. The shelves when fitted, also help to keep the side plates fair and true. When welding the shelves, keep the welds neat and equally spaced, as the shelf is easily viewed from inside the boat. The kill tank must be folded and



fitted before the floor plates are fitted. The floor plates are pushed hard against the side plates and tacked in place.

Now for those external coamings, fit these and weld in place. These can be fully welded or stitch welded.



With the gunnel coamings tacked on, check the construction drawing dimension, tack a brace from outer edge to outer edge, (gunnel edge), mark a midpoint and attach a plumb bob - it should sit dead on the keel. This level checking, and careful alignment now pays its due. The hull will be square, true and all panels aligned perfectly.

It is easy to see the bilge pump outlet we spoke about before. This can be welded externally and then trimmed



off. The outer coaming can be stopped at the upper cockpit transom corner, or continued down at an angle to the swim platform.



On the casting deck of this boat we made a small change and fitted a large and small hinged lid, instead of the normal hatches. That is the great thing about aluminium, things can be changed easily and the material is easy to work with. The picture above shows some channel being placed around the underside perimeter, and this will ensure that the storage area underneath remains dry. Any water flowing onto the cast deck will drain into the channel, off onto the floor then out the scuppers.

Time to fit the transducer brackets at the rear, also grab handles and any other small items. The bollards, scuppers and transducer brackets are included in the kit and the formar can be positioned where you prefer. Handrail material is also included in the kit and you can size and position the handrails to suit your preference.

In this picture, Triff, (with dust mask and goggles), is shown sanding those small heat marks that come through the plate after the



welding process. These marks are easily sanded, again using the large 6 or 7 inch pad, with wax.

After all the sanding has been completed, then the hull must be degreased before painting. Epoxy filler can be applied to internal and external joints if desired, (that is another article in itself), and then the vessel can be painted.

The sequence we use is 2 pack etch primer, epoxy filler, epoxy undercoat then epoxy topcoat.

For the filling of those internal corners and covering up the welds with a large smooth radius, we use International HT9000 two pack epoxy, (with micro



balloons), for filling. We can supply 1 litre epoxy kits for doing this if you are interested.

With regards to the painting, previous PAB articles have a good explanation of preparation and painting, so you can look up what is a great article, if desired. (*Especially PAB#3 -Ed*)

If you do not wish to paint the boat, a rough sanded finish is non-glary and easily achieved by sanding the panels using 60 grit sandpaper. If it is intended not to paint the boat before you start your project, (FYI it will save you lots of time and at least \$1000- in paint and filler), it may be worth sanding all topside and visually seen parts (both sides) before assembling the boat, especially the shelves and near edges and corners as when welded in place, it is impossible to get the sander into all of these corners, and it is much easier to sand when flat.

After painting, the fit out can commence. Hatches and bait board can be fitted. The tape just protects the edges when you are working around the vessel.

In the pic (top right) we can see the fuel filler, and vent lines in place. The fuel system needs to be leak tested before the cover panel is fitted. The fuel supply line is fed through the tube to the starboard side where the fuel filter is located above the shelf.

There is a removable section of flooring in the centre of the floor. This is designed to allow buoyancy foam to be fitted to the hull once complete. The buoyancy foam is a requirement for the Australian Builder Plate, (ABP). The ABP data is supplied with the kit, and this contains the required foam volume for the loading as noted for this design.

When the kit build is finished, we supply an ABP plate, but a receipt for the required amount of buoyancy foam



must be seen, and a statutory document noting that the foam has been fitted to the hull must also be completed.

Once the foam is fitted, the central floor plates can be fitted and screwed down.

Carpet is optional, another way of floor covering is an epoxy filled with grit for non slip.

At the helm, hydraulic steering, a switch panel, and a Depth / GPS Combo unit fitted later on, will provide a basic fit out. The fit out can be an expensive exercise, especially with the electronic options available, but the boat can be built with provision to upgrade when then funds permit. Always give thought to under floor connections and or wiring before the main plates are welded in.

When fitting out, we try to minimize stainless fittings and use all alloy closed rivets where possible. This is normally on soft patches, removable deck panels, and other plastic parts. Where stainless must be used it is best to completely isolate with a nylon spacer, and use Durolec paste.

With some graphics work and a digital print applied to both sides, the boat is now finished.

With the addition of a back and front bimini, the boat is complete and this one ended up on another "Trailer Made Australia " trailer.

Regarding trailers: Our preference is a skid type trailer, with keel roller support. A good trailer is expensive, and many kit builders make their own and end up with a product as good, or much better than you could buy anywhere.

We have looked at many and our preference for our stocked trailer range are "Trailer Made Australia" trailers. These are available with galvanized or aluminium frames, depending on the size and offer heavy duty chassis, with excellent adjustability and walkway fitted as standard.

Remember, all the major trailer manufacturers make a product which has to fit the largest combination boats in the market for that size. They are made with adjustable components, skids and rollers, to do just this. With a plate boat, you have the bottom hull profile, so you can match exactly the support frames with Teflon skids, there can be no better. If you fancy building your own, there are companies (AL-KO, in particular) which supply components, and it can be easily done.

PAB-5



4.8m Side Console Technical Specifications & Build Data

What is in the Kit?

All plating, precision CNC cut and marked. Full height frames, all extrusions, bollards, scuppers, inspection ports and drain plugs. Hatch cutouts, kill tank and fuel tank and CNC cut timber jig frames are also included.

Also included, construction drawings, CD with pictures showing build sequence, and Jig frame drawing.

Technical Specifications:

Material: 5083 Marine Grade Aluminium
 Bottom Plates, Stringers, Transom, rear plates – 4mm
 Sides, frames, gunnel plates, cabin and floor plates – 4mm

Extrusions – Deck longitudinals, inner coamings, external gunnels and keelson (pre-rolled). Also flat bar, angle, and handrail tubes.

Hull Weight finished raw. - 500 Kg
 Typical BMT weight – 850-900 Kg. (Dry) approx.

Pack Size and Weight:

Skid 6.2m x 1.9m x 0.3m, Approx. 600 Kg Plus (incl. pallet)

Also 1 small carton.

(Containing construction drawings, bollards, scuppers, small parts and Build CD (etc) – Sent by Registered Post.)

Costs: Vessel Kit

- 4.8m **Side Console** \$8,700 + gst (at May, 2010)
(Console, kill tank & fuel tank included)
- 4.8m **Centre Console** \$7,280 + gst (at May, 2010)
(Console & tank optional)
- 4.8m **Runabout** \$7,900 + gst (at May, 2010) (Fuel tank optional)

Notes: Kit prices will vary with aluminium price
 Cut options, all kits are cut in-house and small customisations can be done.

Building Consumables:

2 “G” size bottles Argon (approx.)
 2 rolls, 1.2mm diameter 5356 Welding Wire.
 Sanding and cut off discs

Boat fit out components can be supplied, in addition to trailers, welders, Mig wire etc..

Available From:

Plate Alloy Australia Pty Ltd.

Tel: (03) 9555 6399

Fax: (03) 9555 6499

Website: www.platealloy.com

Email: sales@platealloy.com